



LC2123

3A 1.5MHz 5.5V Synchronous Buck Converter

DESCRIPTION

The LC2123 is a high efficiency synchronous, buck DC/DC converter. Its input voltage range is from 2.6V to 5.5V and provides an adjustable regulated output voltage from 0.8V to 5.5V while delivering up to 3A of output current.

The internal synchronous switches increase efficiency and eliminate the need for an external Schottky diode. The switching frequency is set by an external resistor or can be synchronized to an external clock. The 100% duty cycle provides low dropout operation extending battery life in portable systems.

The LC2123 is operated in forced continuous PWM Mode which minimizes ripple voltage and reduces the noise and RF interference.

The LC2123 is available in the SOP8 package

FEATURES

- Adjustable Output Voltage, $V_{fb}=0.8V$
- Maximum output current is 3A
- Range of operation input voltage: Max 5.5V
- Standby current: 0.5mA (typ.)
- Line regulation: 0.1%/V (typ.)
- Load regulation: 10mV (typ.)
- High efficiency, up to 96%
- Environment Temperature: $-20^{\circ}C \sim 85^{\circ}C$

APPLICATIONS

- Power Management for 3G modem
- 3W LED driver from Li-ion battery
- LCD Monitor and LCD TV
- DVD Decode Board
- ADSL Modem
- Post Regulators for Switching Supplies

TYPICAL APPLICATION

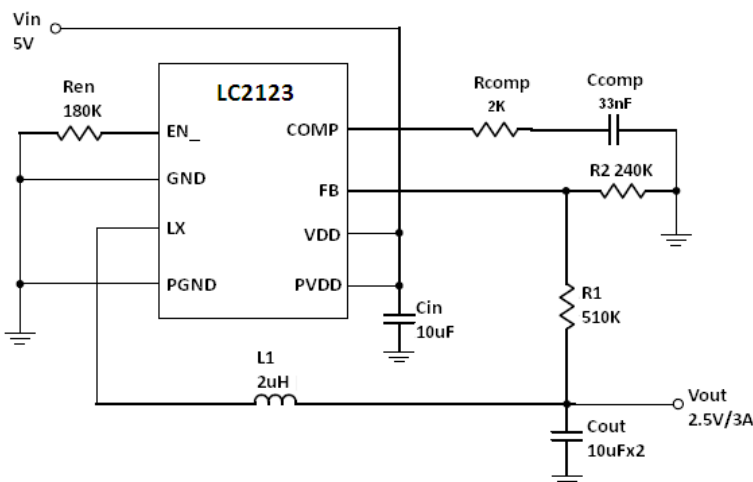

PIN OUT & MARKING

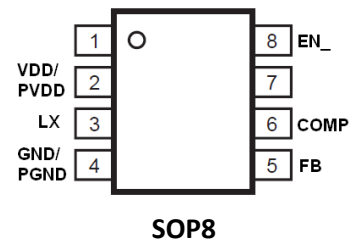

ORDERING INFORMATION

PART No.	PACKAGE	Tape&Reel
LC2123CD8TR	SOP8	2500/Reel

ABSOLUTE MAXIMUM RATING

Parameter	Value
Max Input Voltage	6.5V
Max Operating Junction Temperature(Tj)	125°C
Ambient Temperature(Ta)	-20°C – 85°C
Package Thermal Resistance	DFN3x3-10 20°C / W
Storage Temperature(Ts)	-40°C - 150°C
Lead Temperature & Time	260°C, 10S
ESD (HBM)	>2000V

Note: Exceed these limits to damage to the device. Exposure to absolute maximum rating conditions may affect device reliability.

RECOMMENDED WORK CONDITIONS

Parameter	Value
Input Voltage Range	Max. 6V
Operating Junction Temperature(Tj)	-20°C –125°C

ELECTRICAL CHARACTERISTICS

(VDD=5V, TA=25°C)

Symbol	Parameter	Conditions	Min	Typ	Max	Unit
VDD	Input Voltage Range		3.6		6	V
Vref	Feedback Voltage		0.784	0.8	0.816	V
I _{fb}	Feedback Leakage current			0.1	0.4	uA
I _q	Quiescent Current	Active, V _{fb} =0.78, No Switching		450		uA
		Shutdown		1		uA
LnReg	Line Regulation	V _{in} =4V to 5.5V		0.1		%/V
LdReg	Load Regulation	I _{out} =1 to 3A		0.02		%/A
G _m	EA Transconductance			600		us
F _{soc}	Switching Frequency	R _{en} =180K		1.35		MHz
R _{dsonP}	PMOS R _{dson}			150		mohm
R _{dsonN}	NMOS R _{dson}			130		mohm
I _{limit}	Peak Current Limit			3.8		A
V _{en}	EN_ Shutdown Voltage		V _{in} -0.7V		V _{in}	

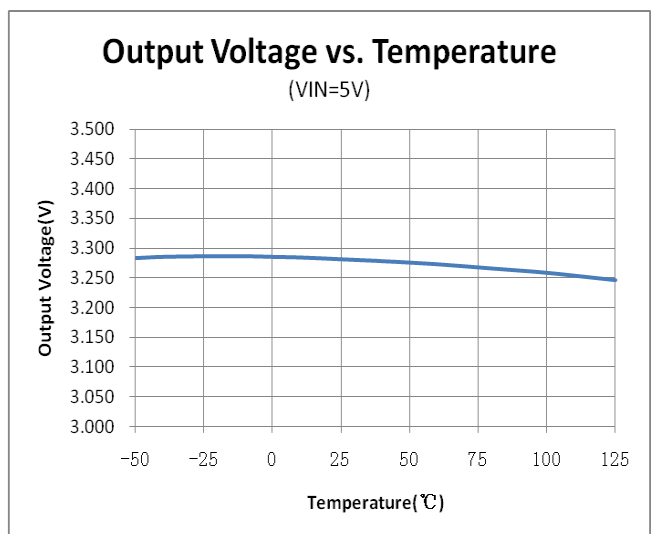
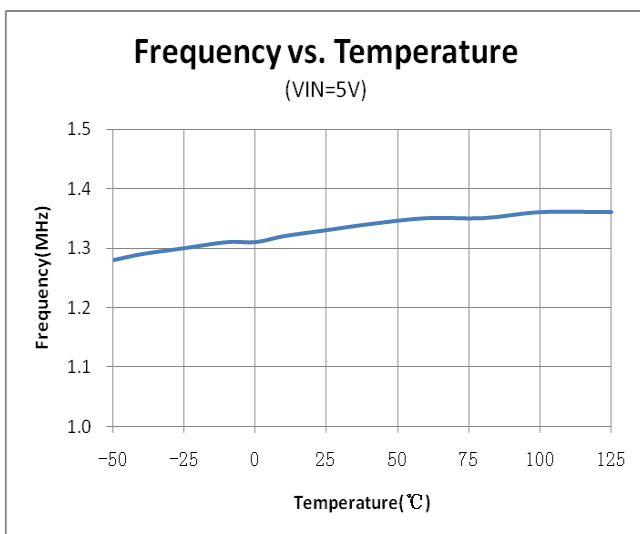
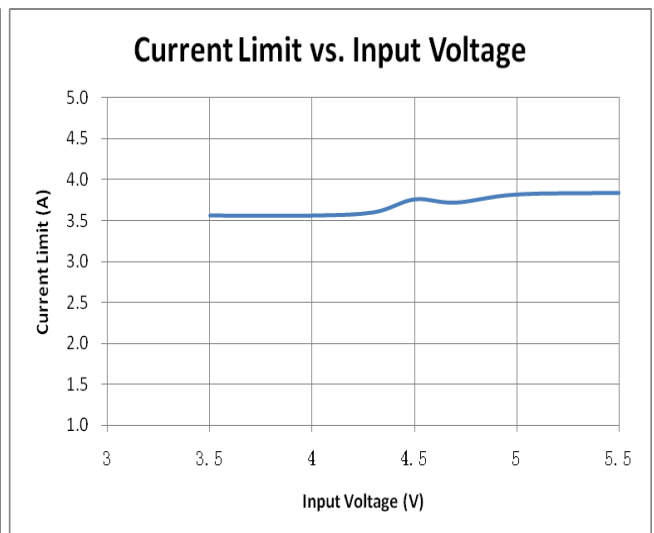
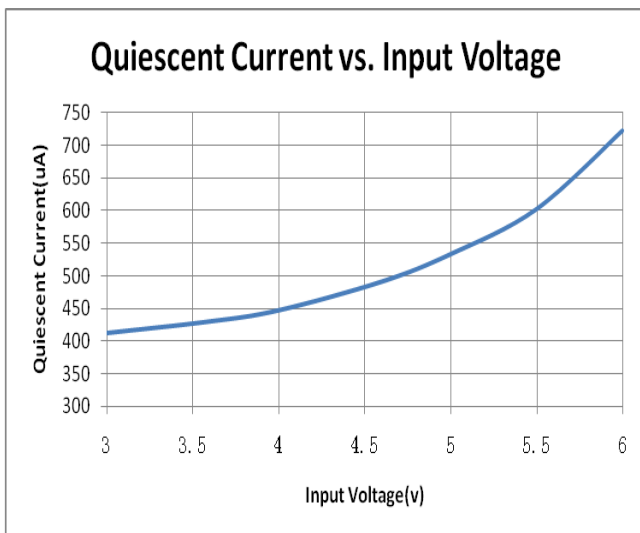
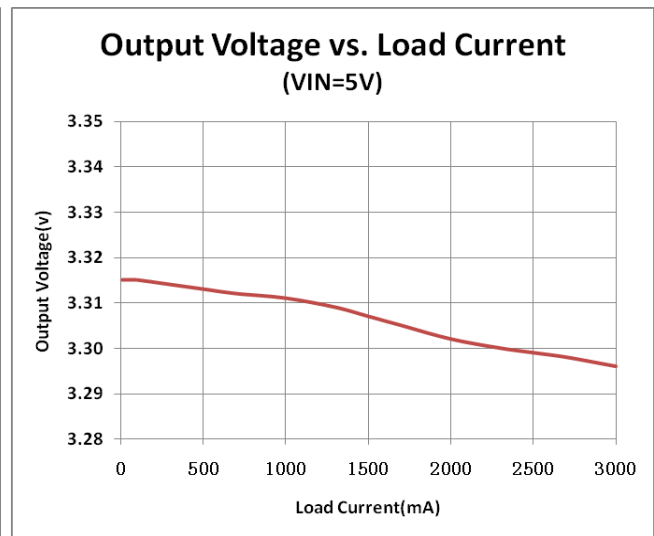
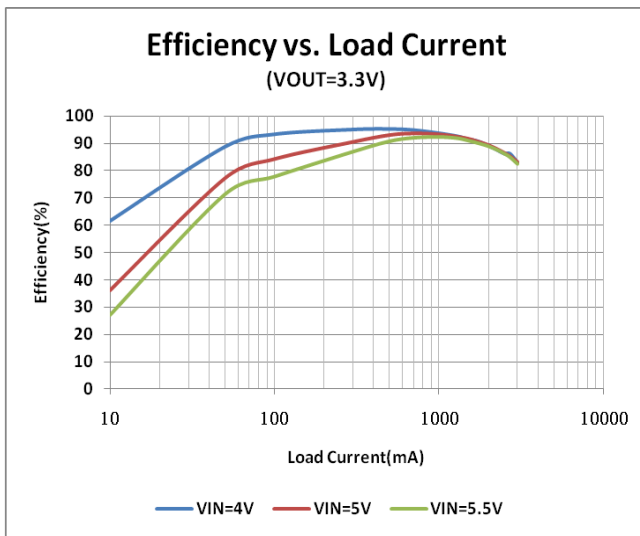

Power On & Soft Start

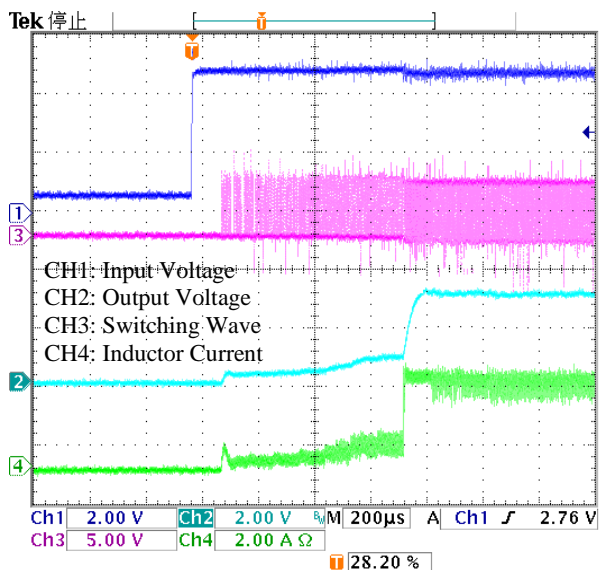

Load Transient Response

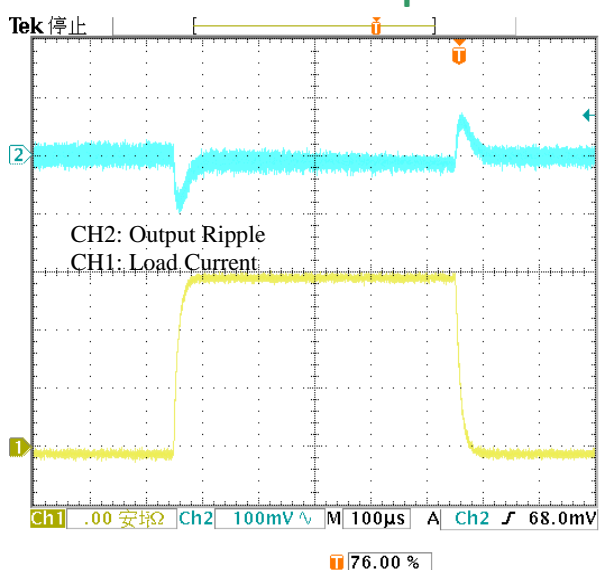

DETAILED DESCRIPTION

LC2123 is a 3A synchronous buck, with frequency adjusted by Ren_. It can achieve conversion efficiency up to 95%. It also support 100% duty cycle which will maximize the battery usage. Only a inductor and a few R & C need for peripheral. The PCB size can be very small

Please note that EN_ pin has to be pull high if one wants to shutdown the chip. And release it (with a Ren_ connected to GND) to have it work.

(请注意，要关断该颗 IC 和输出，EN_脚必须拉高，要使 IC 工作，必须释放该 EN_，控制 EN_脚的前级输出必须高阻，同时 EN_脚接与推荐值 180K 同数量级的电阻到地，电阻阻值变化可以微调震荡频率)

SiiTek 代理商：深圳市琪远电子有限公司
电话:(0755)86228541 / 17727576605
更多产品请访问：www.siitek.com.cn